

DuoDrive

22211.0801



TEXTRON POWER TRANSMISSION

DuoDrive Pinch Roll Speed Reducers

0107

- Solid or Hollow Output Shafts
- Double Extended Input or Output Shafts
- Ratios up to 4,900:1
- Water and Fan Cooling
- Motor Bell and Coupling NEMA 56 to 256

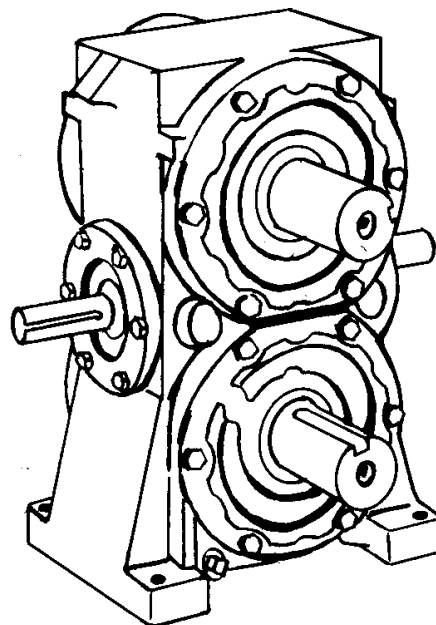

Worm gear units are comprised of one worm input shaft driving two gears on parallel output shafts, one shaft turns clockwise while the other turns counter clockwise providing synchronous drive operation.

Output Torque capacity up to 2,600,000 lb.in.

Base Mount with hollow or solid output shaft in single and double reduction type. Double reduction DuoDrive can be furnished by using the same worm gear primary.

Water cooling with finned O.D. tubing is available for sizes D40 through D240. Fan cooling is available for limited sizes, please contact Textron Power Transmission. An oil circulation pump may be mounted and driven directly from the blind end of a single extended input shaft for size D40 through D240.

Notes:
 Hollow shaft bore sizes, motorizing options, hand of assembly and mounting position numbers follow in this catalog.
 For ratings above size D-120, or the availability of vertical shaft units, or motorizing options, please contact Textron Power Transmission.

Table of Contents

	<u>Page</u>
Ratings	
Size 20 through 120 _____	3 - 13
<i>For ratings above size 120, please contact Textron Power Transmission</i>	
Dimensions	
Size 20 through 240 _____	14 - 15
Motorizing <i>For motorizing options, please contact Textron Power Transmission</i>	
Water Cooling _____	16 - 17
Standard Hollow Gearshaft Bores _____	18
Size 20 through 120	
Assembly and Mounting Positions _____	19

0107

DuoDrive Size D20 (expanded rating table)

Reducer Size		4.00 Inch (Center Distance at Output Shafts)							
20		Worm RPM							
Ratio to 1		100	200	300	580	720	870	1150	1750
5	Me.HP	0.8	1.3	1.9	3.3	3.9	4.5	5.4	6.7
	Th.HP Std	0.4	0.7	1.0	1.7	2.0	2.4	2.8	3.2
	Th.HP Fan								
	Efficiency	89	90	91	91	91	92	92	92
	O.T. / Shaft	1,900	1,650	1,600	1,450	1,350	1,350	1,200	1,000
10	Me.HP	0.5	0.9	1.2	2.1	2.5	2.9	3.5	4.5
	Th.HP Std	0.3	0.5	0.7	1.1	1.4	1.6	1.9	2.4
	Th.HP Fan								
	Efficiency	83	85	86	87	87	89	90	90
	O.T. / Shaft	2,300	2,150	1,900	1,750	1,700	1,650	1,550	1,300
15	Me.HP	0.4	0.6	0.9	1.5	1.8	2.1	2.5	3.2
	Th.HP Std	0.2	0.4	0.5	0.8	1.0	1.1	1.3	1.7
	Th.HP Fan								
	Efficiency	79	81	82	85	85	87	88	88
	O.T. / Shaft	2,650	2,050	2,050	1,850	1,800	1,750	1,600	1,350
20	Me.HP	0.3	0.5	0.7	1.2	1.4	1.6	1.9	2.5
	Th.HP Std	0.2	0.3	0.4	0.6	0.8	0.9	1.0	1.3
	Th.HP Fan								
	Efficiency	75	77	78	83	83	83	84	85
	O.T. / Shaft	2,500	2,150	2,050	1,900	1,800	1,700	1,550	1,350
25	Me.HP	0.2	0.4	0.6	0.9	1.1	1.3	1.6	2.0
	Th.HP Std	0.2	0.2	0.3	0.5	0.6	0.7	0.9	1.1
	Th.HP Fan								
	Efficiency	71	75	77	81	81	83	84	84
	O.T. / Shaft	2,000	2,100	2,150	1,750	1,750	1,750	1,650	1,350
30	Me.HP	0.2	0.3	0.5	0.8	0.9	1.1	1.3	1.7
	Th.HP Std	0.1	0.2	0.3	0.4	0.5	0.6	0.7	0.9
	Th.HP Fan								
	Efficiency	68	70	72	75	75	79	80	80
	O.T. / Shaft	2,250	1,750	2,000	1,750	1,600	1,700	1,500	1,300
40	Me.HP	0.2	0.3	0.4	0.6	0.7	0.8	1.0	1.3
	Th.HP Std	0.1	0.2	0.2	0.3	0.4	0.5	0.6	0.7
	Th.HP Fan								
	Efficiency	61	63	67	72	75	75	76	76
	O.T. / Shaft	2,700	2,100	2,000	1,650	1,650	1,550	1,500	1,250
50	Me.HP	0.1	0.2	0.3	0.5	0.6	0.7	0.8	1.0
	Th.HP Std	0.1	0.1	0.2	0.3	0.3	0.4	0.5	0.6
	Th.HP Fan								
	Efficiency	54	60	64	70	70	72	73	73
	O.T. / Shaft	1,500	1,700	1,800	1,700	1,650	1,600	1,400	1,150
60	Me.HP	0.1	0.2	0.3	0.4	0.5	0.6	0.7	0.9
	Th.HP Std	0.1	0.1	0.2	0.3	0.3	0.3	0.4	0.5
	Th.HP Fan								
	Efficiency	53	59	61	66	66	69	70	70
	O.T. / Shaft	1,800	2,000	2,050	1,550	1,550	1,600	1,450	1,200

Key: Me.HP = Mech. Input Power (HP)
O.T. / Shaft = Output Torque (Lb.-in) per shaft

Th.HP Std = Ther. Input Power - No Fan
Th.HP Fan = Ther. Input Power - Fan

0107

DuoDrive Size D25 (expanded rating table)

Reducer Size		5.00 Inch (Center Distance at Output Shafts)							
25		Worm RPM							
Ratio to 1		100	200	300	580	720	870	1150	1750
5	Me.HP	1.4	2.5	3.6	6.2	7.3	8.3	9.6	12.1
	Th.HP Std	0.8	1.4	2.0	3.4	3.8	4.0	4.3	4.8
	Th.HP Fan								
	Efficiency	89	90	91	91	91	92	92	92
	O.T. / Shaft	3,550	3,150	3,050	2,700	2,550	2,450	2,150	1,800
10	Me.HP	0.9	1.6	2.3	4.0	4.7	5.4	6.4	8.0
	Th.HP Std	0.5	0.9	1.3	2.2	2.6	3.0	3.5	3.9
	Th.HP Fan								
	Efficiency	83	85	86	87	87	89	90	90
	O.T. / Shaft	4,150	3,750	3,650	3,350	3,150	3,050	2,800	2,300
15	Me.HP	0.7	1.2	1.6	2.8	3.4	3.8	4.6	5.7
	Th.HP Std	0.4	0.7	0.9	1.6	1.8	2.1	2.5	3.1
	Th.HP Fan								
	Efficiency	79	81	82	85	85	87	88	88
	O.T. / Shaft	4,600	4,050	3,650	3,400	3,350	3,150	2,950	2,400
20	Me.HP	0.5	0.9	1.3	2.2	2.6	2.9	3.5	4.4
	Th.HP Std	0.3	0.5	0.7	1.2	1.4	1.6	1.9	2.4
	Th.HP Fan								
	Efficiency	75	77	78	83	83	83	84	85
	O.T. / Shaft	4,150	3,850	3,750	3,500	3,350	3,100	2,850	2,400
25	Me.HP	0.4	0.7	1.0	1.8	2.1	2.4	2.8	3.5
	Th.HP Std	0.3	0.4	0.6	1.0	1.2	1.3	1.6	1.9
	Th.HP Fan								
	Efficiency	71	75	77	81	81	83	84	84
	O.T. / Shaft	3,950	3,650	3,550	3,500	3,300	3,200	2,850	2,350
30	Me.HP	0.4	0.6	0.9	1.5	1.8	2.0	2.4	3.0
	Th.HP Std	0.2	0.4	0.5	0.8	1.0	1.1	1.3	1.6
	Th.HP Fan								
	Efficiency	68	70	72	75	75	79	80	80
	O.T. / Shaft	4,500	3,500	3,600	3,250	3,150	3,050	2,800	2,300
40	Me.HP	0.3	0.5	0.7	1.1	1.3	1.5	1.8	2.3
	Th.HP Std	0.2	0.3	0.4	0.6	0.7	0.8	1.0	1.3
	Th.HP Fan								
	Efficiency	61	63	67	72	75	75	76	76
	O.T. / Shaft	4,050	3,500	3,450	3,050	3,000	2,900	2,650	2,250
50	Me.HP	0.2	0.4	0.5	0.9	1.1	1.2	1.5	1.8
	Th.HP Std	0.2	0.2	0.3	0.5	0.6	0.7	0.8	1.0
	Th.HP Fan								
	Efficiency	54	60	64	70	70	72	73	73
	O.T. / Shaft	3,000	3,350	2,950	3,000	2,950	2,750	2,650	2,100
60	Me.HP	0.2	0.3	0.5	0.8	0.9	1.0	1.2	1.5
	Th.HP Std	0.1	0.2	0.3	0.4	0.5	0.6	0.7	0.9
	Th.HP Fan								
	Efficiency	53	59	61	66	66	69	70	70
	O.T. / Shaft	3,550	2,950	3,400	3,050	2,750	2,650	2,450	2,000

Key: Me.HP = Mech. Input Power (HP)
O.T. / Shaft = Output Torque (Lb.-in) per shaft

Th.HP Std = Ther. Input Power - No Fan
Th.HP Fan = Ther. Input Power - Fan

0107

DuoDrive Size D30 (expanded rating table)

Reducer Size		6.00 Inch (Center Distance at Output Shafts)							
30		Worm RPM							
Ratio to 1		100	200	300	580	720	870	1150	1750
5	Me.HP	2.4	4.5	6.4	10.7	12.2	13.6	15.8	19.9
	Th.HP Std	1.6	2.4	3.0	4.3	4.8	5.1	5.5	6.0
	Th.HP Fan								
	Efficiency	89	90	91	91	91	92	92	92
	O.T. / Shaft	5,950	5,600	5,350	4,650	4,300	4,000	3,500	2,900
10	Me.HP	1.6	2.9	4.1	7.0	8.2	9.3	10.9	13.6
	Th.HP Std	1.1	2.0	2.8	3.8	4.1	4.3	4.6	4.9
	Th.HP Fan								
	Efficiency	83	85	86	87	87	89	90	90
	O.T. / Shaft	7,350	6,800	6,500	5,800	5,500	5,250	4,750	3,900
15	Me.HP	1.1	2.0	2.9	5.0	5.8	6.6	7.7	9.6
	Th.HP Std	0.8	1.4	2.0	3.3	3.5	3.6	3.8	4.0
	Th.HP Fan								
	Efficiency	79	81	82	85	85	87	88	88
	O.T. / Shaft	7,200	6,700	6,600	6,100	5,700	5,500	4,900	4,000
20	Me.HP	0.9	1.6	2.2	3.8	4.5	5.1	6.0	7.4
	Th.HP Std	0.6	1.1	1.5	2.6	3.1	3.3	3.4	3.5
	Th.HP Fan								
	Efficiency	75	77	78	83	83	83	84	85
	O.T. / Shaft	7,450	6,800	6,350	6,000	5,750	5,400	4,850	4,000
25	Me.HP	0.7	1.3	1.8	3.1	3.6	4.1	4.8	6.0
	Th.HP Std	0.5	0.9	1.2	2.1	2.5	2.8	2.8	2.9
	Th.HP Fan								
	Efficiency	71	75	77	81	81	83	84	84
	O.T. / Shaft	6,850	6,750	6,400	6,000	5,600	5,400	4,850	4,000
30	Me.HP	0.6	1.1	1.5	2.6	3.0	3.4	4.1	5.1
	Th.HP Std	0.4	0.8	1.0	1.8	2.1	2.4	2.6	2.6
	Th.HP Fan								
	Efficiency	68	70	72	75	75	79	80	80
	O.T. / Shaft	6,750	6,400	6,000	5,600	5,200	5,150	4,750	3,900
40	Me.HP	0.5	0.8	1.2	2.0	2.3	2.6	3.1	3.8
	Th.HP Std	0.3	0.6	0.8	1.4	1.6	1.8	2.1	2.4
	Th.HP Fan								
	Efficiency	61	63	67	72	75	75	76	76
	O.T. / Shaft	6,750	5,600	5,950	5,500	5,300	4,950	4,550	3,650
50	Me.HP	0.4	0.7	0.9	1.6	1.9	2.1	2.5	3.1
	Th.HP Std	0.3	0.5	0.7	1.1	1.3	1.4	1.7	2.1
	Th.HP Fan								
	Efficiency	54	60	64	70	70	72	73	73
	O.T. / Shaft	6,000	5,800	5,300	5,350	5,100	4,800	4,400	3,600
60	Me.HP	0.3	0.6	0.8	1.3	1.6	1.8	2.1	2.6
	Th.HP Std	0.2	0.4	0.6	0.9	1.1	1.2	1.4	1.8
	Th.HP Fan								
	Efficiency	53	59	61	66	66	69	70	70
	O.T. / Shaft	5,300	5,900	5,400	4,900	4,900	4,750	4,250	3,450

Key: Me.HP = Mech. Input Power (HP)
O.T. / Shaft = Output Torque (Lb.-in) per shaft

Th.HP Std = Ther. Input Power - No Fan
Th.HP Fan = Ther. Input Power - Fan

0107

DuoDrive Size D35 (expanded rating table)

Reducer Size		7.00 Inch (Center Distance at Output Shafts)							
35		Worm RPM							
Ratio to 1		100	200	300	580	720	870	1150	1750
5	Me.HP	4.5	8.3	11.6	18.9	21.7	24.0	27.9	34.4
	Th.HP Std	2.0	3.4	4.3	6.2	6.9	7.4	8.0	8.8
	Th.HP Fan	2.9	5.0	6.5	9.2	10.3	11.1	12.0	13.2
	Efficiency	89	90	91	91	91	92	92	92
	O.T. / Shaft	11,100	10,250	9,700	8,200	7,550	7,000	6,200	5,000
10	Me.HP	2.9	5.3	7.5	12.6	14.5	16.2	18.8	23.4
	Th.HP Std	1.3	2.3	3.3	5.0	5.5	5.9	6.3	6.7
	Th.HP Fan	2.0	3.5	5.0	7.5	8.3	8.9	9.5	10.1
	Efficiency	83	85	86	87	87	89	90	90
	O.T. / Shaft	13,300	12,450	11,900	10,450	9,700	9,150	8,150	6,650
15	Me.HP	2.1	3.7	5.3	8.9	10.3	11.5	13.3	16.7
	Th.HP Std	0.9	1.6	2.3	3.9	4.5	5.0	5.8	5.3
	Th.HP Fan	1.4	2.4	3.5	5.9	6.8	7.5	8.7	8.0
	Efficiency	79	81	82	85	85	87	88	88
	O.T. / Shaft	13,750	12,400	12,000	10,800	10,100	9,550	8,450	6,950
20	Me.HP	1.6	2.9	4.0	6.8	7.9	8.9	10.3	12.9
	Th.HP Std	0.7	1.3	1.8	3.0	3.5	3.9	4.3	4.5
	Th.HP Fan	1.1	2.0	2.7	4.5	5.3	5.9	6.5	6.8
	Efficiency	75	77	78	83	83	83	84	85
	O.T. / Shaft	13,250	12,350	11,500	10,750	10,050	9,400	8,300	6,950
25	Me.HP	1.3	2.3	3.3	5.5	6.4	7.2	8.3	10.4
	Th.HP Std	0.6	1.0	1.5	2.4	2.8	3.1	3.6	3.7
	Th.HP Fan	0.9	1.5	2.3	3.6	4.2	4.7	5.4	5.6
	Efficiency	71	75	77	81	81	83	84	84
	O.T. / Shaft	12,750	11,900	11,700	10,600	9,950	9,500	8,400	6,900
30	Me.HP	1.1	1.9	2.8	4.6	5.4	6.0	7.0	8.7
	Th.HP Std	0.5	0.9	1.2	2.0	2.4	2.6	3.1	3.2
	Th.HP Fan	0.8	1.4	1.8	3.0	3.6	3.9	4.7	4.8
	Efficiency	68	70	72	75	75	79	80	80
	O.T. / Shaft	12,400	11,000	11,150	9,850	9,350	9,050	8,100	6,600
40	Me.HP	0.8	1.5	2.1	3.5	4.0	4.5	5.3	6.6
	Th.HP Std	0.4	0.7	0.9	1.5	1.8	2.0	2.3	2.8
	Th.HP Fan	0.6	1.1	1.4	2.3	2.7	3.0	3.5	4.2
	Efficiency	61	63	67	72	75	75	76	76
	O.T. / Shaft	10,800	10,450	10,350	9,600	9,200	8,600	7,750	6,350
50	Me.HP	0.7	1.2	1.7	2.8	3.3	3.7	4.2	5.3
	Th.HP Std	0.3	0.5	0.8	1.3	1.4	1.6	1.9	2.3
	Th.HP Fan	0.5	0.8	1.2	2.0	2.1	2.4	2.9	3.5
	Efficiency	54	60	64	70	70	72	73	73
	O.T. / Shaft	10,450	9,950	10,000	9,350	8,850	8,450	7,350	6,100
60	Me.HP	0.6	1.0	1.4	2.4	2.7	3.1	3.5	4.4
	Th.HP Std	0.3	0.5	0.6	1.1	1.2	1.4	1.6	2.0
	Th.HP Fan	0.5	0.8	0.9	1.7	1.8	2.1	2.4	3.0
	Efficiency	53	59	61	66	66	69	70	70
	O.T. / Shaft	10,550	9,800	9,450	9,050	8,200	8,150	7,050	5,850

Key: Me.HP = Mech. Input Power (HP)
O.T. / Shaft = Output Torque (Lb.-in) per shaft

Th.HP Std = Ther. Input Power - No Fan
Th.HP Fan = Ther. Input Power - Fan

0107

DuoDrive Size D40 (expanded rating table)

Reducer Size		8.00 Inch (Center Distance at Output Shafts)							
40		Worm RPM							
Ratio to 1		100	200	300	580	720	870	1150	1750
5	Me.HP	6.5	11.8	16.5	26.3	29.7	32.8	38.0	46.5
	Th.HP Std	3.4	5.2	6.7	9.5	10.7	11.5	12.4	13.6
	Th.HP Fan	5.1	7.8	10.0	14.3	16.0	17.2	18.6	20.5
	Efficiency	92	93	94	94	94	95	95	95
	O.T. / Shaft	16,500	15,100	14,250	11,750	10,700	9,900	8,650	7,000
10	Me.HP	4.2	7.6	10.7	17.6	20.2	22.4	26.0	32.2
	Th.HP Std	2.3	4.2	5.7	7.8	8.5	9.1	9.7	10.4
	Th.HP Fan	3.5	6.3	8.6	11.7	12.8	13.7	14.6	15.6
	Efficiency	86	88	89	90	90	92	93	93
	O.T. / Shaft	19,950	18,450	17,500	15,100	13,950	13,100	11,600	9,450
15	Me.HP	2.9	5.3	7.5	12.5	14.3	15.9	18.4	22.9
	Th.HP Std	1.6	3.0	4.2	6.9	8.0	7.3	7.7	8.2
	Th.HP Fan	2.4	4.5	6.3	10.4	12.0	11.0	11.6	12.3
	Efficiency	82	84	85	88	89	90	91	91
	O.T. / Shaft	19,700	18,450	17,600	15,700	14,650	13,650	12,050	9,850
20	Me.HP	2.3	4.1	5.8	9.6	11.0	12.2	14.2	17.6
	Th.HP Std	1.3	2.3	3.2	5.3	6.1	6.4	6.6	6.9
	Th.HP Fan	2.0	3.5	4.8	8.0	9.2	9.6	9.9	10.4
	Efficiency	78	80	81	86	86	86	87	88
	O.T. / Shaft	19,800	18,100	17,300	15,700	14,500	13,300	11,850	9,800
25	Me.HP	1.8	3.3	4.7	7.7	8.9	9.9	11.5	14.2
	Th.HP Std	1.0	1.9	2.6	4.3	5.0	5.4	5.5	5.7
	Th.HP Fan	1.5	2.9	3.9	6.5	7.5	8.1	8.3	8.6
	Efficiency	74	78	80	84	84	86	87	87
	O.T. / Shaft	18,400	17,750	17,300	15,400	14,350	13,500	12,000	9,750
30	Me.HP	1.5	2.8	3.9	6.5	7.5	8.3	9.7	12.0
	Th.HP Std	0.9	1.6	2.2	3.6	4.2	4.6	4.8	5.0
	Th.HP Fan	1.4	2.4	3.3	5.4	6.3	6.9	7.2	7.5
	Efficiency	71	73	75	78	81	82	83	83
	O.T. / Shaft	17,650	16,950	16,150	14,500	14,000	12,950	11,600	9,450
40	Me.HP	1.2	2.1	3.0	4.9	5.6	6.3	7.3	9.0
	Th.HP Std	0.7	1.2	1.7	2.7	3.1	3.5	4.1	4.3
	Th.HP Fan	1.1	1.8	2.6	4.1	4.7	5.3	6.2	6.5
	Efficiency	64	66	70	75	76	78	79	79
	O.T. / Shaft	16,950	15,300	15,450	14,000	13,050	12,500	11,100	9,000
50	Me.HP	1.0	1.7	2.4	3.9	4.5	5.0	5.8	7.2
	Th.HP Std	0.5	1.0	1.3	2.2	2.5	2.8	3.3	3.8
	Th.HP Fan	0.8	1.5	2.0	3.3	3.8	4.2	5.0	5.7
	Efficiency	57	63	67	73	74	75	76	76
	O.T. / Shaft	15,750	14,800	14,800	13,550	12,750	11,900	10,600	8,650
60	Me.HP	0.8	1.4	2.0	3.3	3.8	4.2	4.9	6.0
	Th.HP Std	0.5	0.8	1.1	1.9	2.1	2.4	2.7	3.4
	Th.HP Fan	0.8	1.2	1.7	2.9	3.2	3.6	4.1	5.1
	Efficiency	56	62	64	69	71	72	73	73
	O.T. / Shaft	14,850	14,400	14,150	13,000	12,400	11,500	10,300	8,300

Key: Me.HP = Mech. Input Power (HP) Th.HP Std = Ther. Input Power - No Fan
 O.T. / Shaft = Output Torque (Lb.-in) per shaft Th.HP Fan = Ther. Input Power - Fan

0107

DuoDrive Size D50 (expanded rating table)

Reducer Size		10.00 Inch (Center Distance at Output Shafts)							
50		Worm RPM							
Ratio to 1		100	200	300	580	720	870	1150	1750
5	Me.HP	12.8	23.2	32.2	49.6	55.4	61.6	70.4	85.8
	Th.HP Std	4.2	6.4	8.3	11.8	13.2	14.2	15.3	16.9
	Th.HP Fan	6.4	9.6	12.4	17.6	19.7	21.3	23.0	25.3
	Efficiency	92	93	94	94	94	95	95	95
	O.T. / Shaft	32,400	29,750	27,850	22,200	19,950	18,550	16,050	12,850
10	Me.HP	8.2	14.9	20.8	33.0	37.1	41.0	47.6	58.4
	Th.HP Std	3.8	5.5	7.0	9.6	10.5	11.2	12.0	12.8
	Th.HP Fan	5.7	8.3	10.5	14.4	15.8	16.8	18.0	19.2
	Efficiency	86	88	89	90	90	92	93	93
	O.T. / Shaft	38,900	36,150	34,050	28,250	25,600	23,950	21,250	17,150
15	Me.HP	5.7	10.5	14.6	23.4	26.3	29.1	33.7	41.3
	Th.HP Std	3.2	5.8	5.9	7.9	8.5	9.0	9.5	10.1
	Th.HP Fan	4.8	8.7	8.9	11.9	12.8	13.5	14.3	15.2
	Efficiency	82	84	85	88	89	90	91	91
	O.T. / Shaft	38,650	36,500	34,250	29,400	26,900	24,900	22,100	17,800
20	Me.HP	4.4	8.0	11.2	18.0	20.2	22.3	25.9	31.9
	Th.HP Std	2.4	4.2	5.2	7.1	7.5	7.8	8.1	8.5
	Th.HP Fan	3.6	6.3	7.8	10.7	11.3	11.7	12.2	12.8
	Efficiency	78	80	81	86	86	86	87	88
	O.T. / Shaft	37,850	35,300	33,350	29,450	26,650	24,350	21,650	17,700
25	Me.HP	3.6	6.5	9.1	14.5	16.4	18.1	21.0	25.8
	Th.HP Std	2.0	3.6	4.5	6.1	6.4	6.6	6.8	7.1
	Th.HP Fan	3.0	5.4	6.8	9.2	9.6	9.9	10.2	10.7
	Efficiency	74	78	80	84	84	86	87	87
	O.T. / Shaft	36,750	34,950	33,450	28,950	26,400	24,700	21,900	17,700
30	Me.HP	3.0	5.4	7.6	12.2	13.7	15.2	17.6	21.6
	Th.HP Std	1.7	3.0	3.9	5.3	5.6	5.8	5.9	6.1
	Th.HP Fan	2.6	4.5	5.9	8.0	8.4	8.7	8.9	9.2
	Efficiency	71	73	75	78	81	82	83	83
	O.T. / Shaft	35,250	32,600	31,450	27,150	25,500	23,700	21,050	16,950
40	Me.HP	2.3	4.1	5.7	9.2	10.4	11.4	13.3	16.3
	Th.HP Std	1.3	2.3	3.2	5.1	4.8	5.0	5.2	5.3
	Th.HP Fan	2.0	3.5	4.8	7.7	7.2	7.5	7.8	8.0
	Efficiency	64	66	70	75	76	78	79	79
	O.T. / Shaft	32,500	29,850	29,350	26,250	24,250	22,550	20,150	16,250
50	Me.HP	1.8	3.3	4.6	7.4	8.3	9.2	10.7	13.1
	Th.HP Std	1.0	1.8	2.6	3.7	4.0	4.2	4.4	4.7
	Th.HP Fan	1.5	2.7	3.9	5.6	6.0	6.3	6.6	7.1
	Efficiency	57	63	67	73	74	75	76	76
	O.T. / Shaft	28,300	28,700	28,350	25,700	23,550	21,900	19,500	15,700
60	Me.HP	1.5	2.8	3.9	6.2	7.0	7.7	8.9	10.9
	Th.HP Std	0.9	1.5	2.1	3.3	3.5	3.7	4.0	4.3
	Th.HP Fan	1.4	2.3	3.2	5.0	5.3	5.6	6.0	6.5
	Efficiency	56	62	64	69	71	72	73	73
	O.T. / Shaft	27,800	28,750	27,550	24,400	22,850	21,100	18,700	15,050
70	Me.HP	1.3	2.4	3.3	5.3	6.0	6.6	7.7	9.4
	Th.HP Std	0.7	1.3	1.8	2.9	3.3	3.4	3.7	3.8
	Th.HP Fan	1.1	2.0	2.7	4.4	5.0	5.1	5.6	5.7
	Efficiency	55	61	63	68	70	71	72	72
	O.T. / Shaft	27,600	28,250	26,750	24,000	22,550	20,800	18,650	14,950

Key: Me.HP = Mech. Input Power (HP)
O.T. / Shaft = Output Torque (Lb.-in) per shaft

Th.HP Std = Ther. Input Power - No Fan
Th.HP Fan = Ther. Input Power - Fan

0107

DuoDrive Size D60 (expanded rating table)

Reducer Size		12.00 Inch (Center Distance at Output Shafts)							
60		Worm RPM							
Ratio to 1		100	200	300	580	720	870	1150	1750
5	Me.HP	19.5	35.1	47.9	70.5	79.3	87.3	99.8	116.5
	Th.HP Std	6.2	9.3	12.0	17.1	19.1	20.6	22.3	24.5
	Th.HP Fan	9.2	14.0	18.0	25.6	28.7	30.9	33.4	36.8
	Efficiency	92	93	94	94	94	95	95	95
	O.T. / Shaft	49,400	45,000	41,350	31,500	28,550	26,300	22,750	17,450
10	Me.HP	12.5	22.7	31.3	47.5	53.3	59.0	68.2	81.7
	Th.HP Std	5.5	7.9	10.2	13.9	15.2	16.3	17.5	18.6
	Th.HP Fan	8.3	11.9	15.3	20.9	22.8	24.5	26.3	27.9
	Efficiency	86	88	89	90	90	92	93	93
	O.T. / Shaft	59,300	55,100	51,200	40,650	36,750	34,400	30,450	23,950
15	Me.HP	8.8	16.0	22.1	33.7	37.7	41.8	48.1	58.0
	Th.HP Std	4.9	6.9	8.5	11.5	12.3	13.1	13.8	14.7
	Th.HP Fan	7.4	10.4	12.8	17.3	18.5	19.7	20.7	22.1
	Efficiency	82	84	85	88	89	90	91	91
	O.T. / Shaft	59,700	55,600	51,800	42,300	38,550	35,800	31,500	24,950
20	Me.HP	6.7	12.2	16.9	25.9	28.9	32.2	36.9	45.0
	Th.HP Std	3.8	6.1	7.5	10.2	10.8	11.4	11.8	12.3
	Th.HP Fan	5.7	9.2	11.3	15.3	16.2	17.1	17.7	18.5
	Efficiency	78	80	81	86	86	86	87	88
	O.T. / Shaft	57,650	53,850	50,350	42,350	38,100	35,100	30,800	24,950
25	Me.HP	5.4	9.9	13.7	21.0	23.4	26.0	29.9	36.2
	Th.HP Std	3.1	5.2	6.5	8.9	9.3	9.6	9.9	10.2
	Th.HP Fan	4.7	7.8	9.8	13.4	14.0	14.4	14.9	15.3
	Efficiency	74	78	80	84	84	86	87	87
	O.T. / Shaft	55,100	53,250	50,350	41,950	37,650	35,450	31,200	24,850
30	Me.HP	4.6	8.3	11.5	17.6	19.7	21.8	25.0	30.5
	Th.HP Std	2.6	4.4	5.7	7.7	8.1	8.4	8.6	8.9
	Th.HP Fan	3.9	6.6	8.6	11.6	12.2	12.6	12.9	13.4
	Efficiency	71	73	75	78	81	82	83	83
	O.T. / Shaft	54,050	50,150	47,550	39,150	36,700	34,000	29,850	23,950
40	Me.HP	3.4	6.2	8.6	13.3	14.8	16.5	18.8	22.9
	Th.HP Std	1.9	3.5	4.7	7.5	6.9	7.2	7.5	7.7
	Th.HP Fan	2.9	5.3	7.1	11.3	10.4	10.8	11.3	11.6
	Efficiency	64	66	70	75	76	78	79	79
	O.T. / Shaft	48,000	45,150	44,250	37,950	34,450	32,650	28,500	22,800
50	Me.HP	2.8	5.0	6.9	10.7	11.9	13.2	15.1	18.4
	Th.HP Std	1.6	2.8	3.9	5.4	5.7	6.0	6.4	6.9
	Th.HP Fan	2.4	4.2	5.9	8.1	8.6	9.0	9.6	10.4
	Efficiency	57	63	67	73	74	75	76	76
	O.T. / Shaft	44,000	43,450	42,500	37,150	33,750	31,400	27,550	22,050
60	Me.HP	2.3	4.2	5.8	8.9	9.9	11.0	12.6	15.4
	Th.HP Std	1.3	2.4	3.3	4.8	5.0	5.3	5.8	6.2
	Th.HP Fan	2.0	3.6	5.0	7.2	7.5	8.0	8.7	9.3
	Efficiency	56	62	64	69	71	72	73	73
	O.T. / Shaft	42,650	43,100	40,950	35,050	32,300	30,150	26,500	21,250
70	Me.HP	2.0	3.6	5.0	7.6	8.5	9.5	10.8	13.2
	Th.HP Std	1.1	2.0	2.8	4.3	4.7	5.0	5.4	5.5
	Th.HP Fan	1.7	3.0	4.2	6.5	7.1	7.5	8.1	8.3
	Efficiency	55	61	63	68	70	71	72	72
	O.T. / Shaft	42,450	42,400	40,550	34,400	31,900	29,950	26,100	21,000

Key: Me.HP = Mech. Input Power (HP)
O.T. / Shaft = Output Torque (Lb.-in) per shaft

Th.HP Std = Ther. Input Power - No Fan
Th.HP Fan = Ther. Input Power - Fan

0107

DuoDrive Size D70 (expanded rating table)

Reducer Size		14.00 Inch (Center Distance at Output Shafts)							
70		Worm RPM							
Ratio to 1		100	200	300	580	720	870	1150	1750
5	Me.HP	30.6	54.5	72.6	105.2	117.5	128.8	146.2	168.7
	Th.HP Std	8.6	13.0	16.7	23.8	26.6	28.7	31.0	34.1
	Th.HP Fan	12.9	19.5	25.1	35.7	39.9	43.1	46.5	51.2
	Efficiency	92	93	94	94	94	95	95	95
	O.T. / Shaft	77,550	69,800	62,700	47,000	42,300	38,800	33,300	25,250
10	Me.HP	19.7	35.6	48.7	72.1	81.2	89.6	102.6	119.6
	Th.HP Std	7.7	11.0	14.1	19.4	21.2	22.6	24.3	25.9
	Th.HP Fan	11.6	16.5	21.2	29.1	31.8	33.9	36.5	38.9
	Efficiency	86	88	89	90	90	92	93	93
	O.T. / Shaft	93,400	86,350	79,650	61,700	56,000	52,250	45,750	35,050
15	Me.HP	13.8	25.1	34.4	51.3	57.7	63.8	73.0	86.3
	Th.HP Std	8.0	9.6	11.9	16.0	17.2	18.2	19.2	20.5
	Th.HP Fan	12.0	14.4	17.9	24.0	25.8	27.3	28.8	30.8
	Efficiency	82	84	85	88	89	90	91	91
	O.T. / Shaft	93,600	87,200	80,600	64,400	59,000	54,600	47,800	37,150
20	Me.HP	10.6	19.2	26.4	39.4	44.4	48.8	56.0	66.3
	Th.HP Std	5.3	8.5	10.5	14.2	15.1	15.8	16.4	17.2
	Th.HP Fan	8.0	12.8	15.8	21.3	22.7	23.7	24.6	25.8
	Efficiency	78	80	81	86	86	86	87	88
	O.T. / Shaft	91,200	84,700	78,600	64,450	58,500	53,200	46,750	36,800
25	Me.HP	8.5	15.5	21.3	31.9	35.9	39.5	45.5	53.7
	Th.HP Std	4.3	7.3	9.1	12.4	12.9	13.3	13.7	14.2
	Th.HP Fan	6.5	11.0	13.7	18.6	19.4	20.0	20.6	21.3
	Efficiency	74	78	80	84	84	86	87	87
	O.T. / Shaft	86,700	83,350	78,300	63,700	57,750	53,850	47,450	36,800
30	Me.HP	7.2	13.0	17.9	26.8	30.1	33.1	38.1	45.2
	Th.HP Std	4.2	6.1	7.8	10.7	11.2	11.7	12.0	12.3
	Th.HP Fan	6.3	9.2	11.7	16.1	16.8	17.6	18.0	18.5
	Efficiency	71	73	75	78	81	82	83	83
	O.T. / Shaft	84,550	78,500	74,050	59,650	56,050	51,600	45,500	35,500
40	Me.HP	5.4	9.8	13.4	20.1	22.6	24.9	28.8	34.0
	Th.HP Std	2.7	4.9	6.5	11.5	9.6	10.0	10.4	10.7
	Th.HP Fan	4.1	7.4	9.8	17.3	14.4	15.0	15.6	16.1
	Efficiency	64	66	70	75	76	78	79	79
	O.T. / Shaft	76,250	71,350	68,950	57,350	52,650	49,250	43,650	33,850
50	Me.HP	4.3	7.9	10.8	16.2	18.2	20.0	23.1	27.3
	Th.HP Std	2.2	3.9	5.4	7.5	8.0	8.4	8.9	9.6
	Th.HP Fan	3.3	5.9	8.1	11.3	12.0	12.6	13.4	14.4
	Efficiency	57	63	67	73	74	75	76	76
	O.T. / Shaft	67,600	68,600	66,500	56,200	51,600	47,550	42,100	32,700
60	Me.HP	3.6	6.6	9.0	13.5	15.2	16.7	19.3	22.9
	Th.HP Std	1.8	3.3	4.5	6.6	7.0	7.4	8.1	8.6
	Th.HP Fan	2.7	5.0	6.8	9.9	10.5	11.1	12.2	12.9
	Efficiency	56	62	64	69	71	72	73	73
	O.T. / Shaft	66,700	67,700	63,550	53,150	49,600	45,750	40,550	31,600
70	Me.HP	3.1	5.7	7.7	11.6	13.0	14.3	16.5	19.6
	Th.HP Std	1.6	2.8	3.9	5.9	6.6	6.9	7.5	7.6
	Th.HP Fan	2.4	4.2	5.9	8.9	9.9	10.4	11.3	11.4
	Efficiency	55	61	63	68	70	71	72	72
	O.T. / Shaft	65,800	67,100	62,400	52,500	48,800	45,050	39,900	31,150

Key: Me.HP = Mech. Input Power (HP)
O.T. / Shaft = Output Torque (Lb.-in) per shaft

Th.HP Std = Ther. Input Power - No Fan
Th.HP Fan = Ther. Input Power - Fan

0107

DuoDrive Size D80 (expanded rating table)

Reducer Size		16.00 Inch (Center Distance at Output Shafts)							
80		Worm RPM							
Ratio to 1		100	200	300	580	720	870	1150	1750
5	Me.HP	45.3	79.8	104.5	149.3	166.7	182.2	203.8	236.1
	Th.HP Std	9.4	14.3	18.4	26.1	29.3	31.5	34.1	37.5
	Th.HP Fan	14.1	21.4	27.5	39.2	43.9	47.3	51.1	56.2
	Efficiency	92	93	94	94	94	95	95	95
	O.T. / Shaft	114,950	102,250	90,250	66,700	60,000	54,850	46,450	35,350
10	Me.HP	29.3	52.9	71.6	104.8	118.0	129.3	148.8	173.1
	Th.HP Std	8.4	12.1	15.5	21.3	23.3	24.8	26.7	28.5
	Th.HP Fan	12.6	18.2	23.3	32.0	35.0	37.2	40.1	42.8
	Efficiency	86	88	89	90	90	92	93	93
	O.T. / Shaft	138,950	128,350	117,100	89,650	81,350	75,400	66,350	50,750
15	Me.HP	20.6	37.3	50.8	74.8	84.2	93.0	106.3	123.3
	Th.HP Std	8.6	10.5	13.0	17.6	18.8	19.9	21.1	22.5
	Th.HP Fan	12.9	15.8	19.5	26.4	28.2	29.9	31.7	33.8
	Efficiency	82	84	85	88	89	90	91	91
	O.T. / Shaft	139,700	129,550	119,050	93,850	86,100	79,600	69,600	53,050
20	Me.HP	15.8	28.6	39.0	57.6	64.7	71.6	81.6	95.2
	Th.HP Std	5.8	9.4	11.5	15.6	16.5	17.4	18.1	18.8
	Th.HP Fan	8.7	14.1	17.3	23.4	24.8	26.1	27.2	28.2
	Efficiency	78	80	81	86	86	86	87	88
	O.T. / Shaft	135,900	126,150	116,100	94,200	85,250	78,050	68,100	52,800
25	Me.HP	12.7	23.0	31.5	46.7	52.5	57.7	66.2	77.1
	Th.HP Std	4.7	8.0	9.9	13.6	14.1	14.6	15.0	15.6
	Th.HP Fan	7.1	12.0	14.9	20.4	21.2	21.9	22.5	23.4
	Efficiency	74	78	80	84	84	86	87	87
	O.T. / Shaft	129,550	123,650	115,800	93,250	84,450	78,650	69,050	52,850
30	Me.HP	10.7	19.3	26.4	39.1	44.1	48.6	55.7	64.9
	Th.HP Std	4.5	6.6	8.6	11.7	12.3	12.8	13.1	13.5
	Th.HP Fan	6.8	9.9	12.9	17.6	18.5	19.2	19.7	20.3
	Efficiency	71	73	75	78	81	82	83	83
	O.T. / Shaft	125,650	116,500	109,150	87,000	82,050	75,800	66,500	50,950
40	Me.HP	8.0	14.6	19.9	29.5	33.2	36.6	41.9	49.0
	Th.HP Std	2.9	5.4	7.2	12.3	10.5	11.0	11.4	11.8
	Th.HP Fan	4.4	8.1	10.8	18.5	15.8	16.5	17.1	17.7
	Efficiency	64	66	70	75	76	78	79	79
	O.T. / Shaft	112,900	106,250	102,400	84,150	77,300	72,400	63,500	48,800
50	Me.HP	6.5	11.7	16.0	23.7	26.6	29.4	33.6	39.3
	Th.HP Std	2.4	4.3	5.9	8.3	8.7	9.2	9.8	10.5
	Th.HP Fan	3.6	6.5	8.9	12.5	13.1	13.8	14.7	15.8
	Efficiency	57	63	67	73	74	75	76	76
	O.T. / Shaft	102,150	101,600	98,500	82,250	75,400	69,900	61,250	47,050
60	Me.HP	5.4	9.8	13.3	19.8	22.2	24.5	28.1	32.8
	Th.HP Std	2.0	3.6	5.0	7.3	7.7	8.1	8.9	9.4
	Th.HP Fan	3.0	5.4	7.5	11.0	11.6	12.2	13.4	14.1
	Efficiency	56	62	64	69	71	72	73	73
	O.T. / Shaft	100,050	100,500	93,850	77,950	72,450	67,100	59,000	45,300
70	Me.HP	4.6	8.4	11.4	17.0	19.1	21.0	24.1	28.2
	Th.HP Std	1.7	3.1	4.3	6.5	7.2	7.5	8.2	8.4
	Th.HP Fan	2.6	4.7	6.5	9.8	10.8	11.3	12.3	12.6
	Efficiency	55	61	63	68	70	71	72	72
	O.T. / Shaft	97,650	98,900	92,400	76,950	71,700	66,150	58,250	44,800

Key: Me.HP = Mech. Input Power (HP)
O.T. / Shaft = Output Torque (Lb.-in) per shaft

Th.HP Std = Ther. Input Power - No Fan
Th.HP Fan = Ther. Input Power - Fan

0107

DuoDrive Size D100 (expanded rating table)

Reducer Size		20.00 Inch (Center Distance at Output Shafts)							
100		Worm RPM							
Ratio to 1		100	200	300	580	720	870	1150	1750
5	Me.HP	84.7	143.9	183.2	258.3	286.8	311.0	337.9	397.5
	Th.HP Std	14.4	22.3	29.5	42.0	47.0	52.6	56.8	62.5
	Th.HP Fan	21.6	33.4	44.2	63.0	70.5	78.9	85.2	93.7
	Efficiency	94	95	96	96	97	97	97	97
	O.T. / Shaft	219,450	188,400	161,550	117,850	106,500	95,600	78,600	60,750
10	Me.HP	55.1	97.3	128.6	184.1	205.2	224.8	253.5	291.0
	Th.HP Std	11.9	17.4	22.6	31.4	35.5	37.9	41.7	44.5
	Th.HP Fan	17.9	26.1	33.9	47.1	53.3	56.9	62.6	66.8
	Efficiency	88	90	91	92	94	94	95	95
	O.T. / Shaft	267,300	241,400	215,050	161,000	147,700	133,900	115,450	87,100
15	Me.HP	38.7	68.7	91.0	130.9	146.7	160.5	181.7	209.1
	Th.HP Std	9.9	14.7	18.3	25.4	27.5	29.4	31.6	33.7
	Th.HP Fan	14.9	22.1	27.5	38.1	41.3	44.1	47.4	50.6
	Efficiency	84	86	87	90	92	92	93	93
	O.T. / Shaft	268,850	244,300	218,250	168,000	155,000	140,350	121,550	91,900
20	Me.HP	29.6	52.7	70.1	100.7	112.9	124.1	139.5	161.6
	Th.HP Std	7.8	12.8	15.8	22.1	23.4	24.6	25.8	27.2
	Th.HP Fan	11.7	19.2	23.7	33.2	35.1	36.9	38.7	40.8
	Efficiency	80	82	83	88	88	88	89	90
	O.T. / Shaft	261,100	238,250	213,850	168,450	152,150	138,400	119,050	91,650
25	Me.HP	23.9	42.5	56.6	81.6	91.0	99.9	113.3	130.2
	Th.HP Std	6.3	10.8	13.6	18.9	19.8	20.7	21.5	22.3
	Th.HP Fan	9.5	16.2	20.4	28.4	29.7	31.1	32.3	33.5
	Efficiency	76	80	82	86	88	88	89	89
	O.T. / Shaft	250,350	234,300	213,250	166,750	153,300	139,300	120,850	91,300
30	Me.HP	20.0	35.7	47.4	68.4	76.2	83.7	94.9	109.1
	Th.HP Std	6.8	8.9	11.6	15.9	16.9	17.7	18.2	18.8
	Th.HP Fan	10.2	13.4	17.4	23.9	25.4	26.6	27.3	28.2
	Efficiency	73	75	77	80	84	84	85	85
	O.T. / Shaft	241,450	221,400	201,200	156,050	147,050	133,650	116,000	87,650
40	Me.HP	15.1	26.8	35.7	51.4	57.3	63.0	71.4	82.0
	Th.HP Std	3.9	7.1	9.5	17.7	14.3	15.0	15.5	16.1
	Th.HP Fan	5.9	10.7	14.3	26.6	21.5	22.5	23.3	24.2
	Efficiency	66	68	72	77	80	80	81	81
	O.T. / Shaft	219,800	200,950	188,950	150,500	140,400	127,750	110,900	83,700
50	Me.HP	12.1	21.6	28.7	41.5	46.3	50.7	57.8	66.2
	Th.HP Std	3.1	5.6	7.8	11.0	11.7	12.3	13.2	14.1
	Th.HP Fan	4.7	8.4	11.7	16.5	17.6	18.5	19.8	21.2
	Efficiency	59	65	69	75	77	77	78	78
	O.T. / Shaft	196,800	193,500	181,950	147,950	136,500	123,700	108,100	81,350
60	Me.HP	10.1	18.0	24.0	34.6	38.6	42.3	48.2	55.2
	Th.HP Std	2.6	4.7	6.5	9.7	10.2	10.9	11.9	12.6
	Th.HP Fan	3.9	7.1	9.8	14.6	15.3	16.4	17.9	18.9
	Efficiency	58	64	66	71	74	74	75	75
	O.T. / Shaft	193,800	190,550	174,650	140,100	131,250	119,050	104,000	78,250
70	Me.HP	8.7	15.5	20.6	29.7	33.2	36.3	41.4	47.4
	Th.HP Std	2.2	4.0	5.6	8.6	9.6	10.0	10.9	11.2
	Th.HP Fan	3.3	6.0	8.4	12.9	14.4	15.0	16.4	16.8
	Efficiency	57	63	65	70	73	73	74	74
	O.T. / Shaft	191,400	188,450	172,250	138,350	129,900	117,550	102,800	77,350

Key: Me.HP = Mech. Input Power (HP)
O.T. / Shaft = Output Torque (Lb.-in) per shaft

Th.HP Std = Ther. Input Power - No Fan
Th.HP Fan = Ther. Input Power - Fan

0107

DuoDrive Size D120 (expanded rating table)

Reducer Size		24.00 Inch (Center Distance at Output Shafts)						
		Worm RPM						
Ratio to 1		100	200	300	580	720	870	1150
5	Me.HP	142.5	233.9	291.0	407.0	448.5	471.0	525.8
	Th.HP Std	19.8	30.6	40.6	57.8	64.7	72.3	78.1
	Th.HP Fan	29.7	45.9	60.8	86.7	97.0	108.5	117.2
	Efficiency	94	95	96	96	97	97	97
	O.T. / Shaft	369,100	306,200	256,650	185,700	166,550	144,750	122,250
10	Me.HP	93.5	160.9	206.2	293.5	324.0	354.2	386.7
	Th.HP Std	16.4	23.9	31.1	43.1	48.8	52.1	57.3
	Th.HP Fan	24.6	35.9	46.7	64.7	73.2	78.2	86.0
	Efficiency	88	90	91	92	94	94	95
	O.T. / Shaft	453,600	399,150	344,800	256,650	233,200	211,000	176,100
15	Me.HP	65.6	113.6	146.9	209.1	231.3	253.5	276.8
	Th.HP Std	13.6	20.2	25.2	34.9	37.8	40.5	43.4
	Th.HP Fan	20.4	30.3	37.8	52.4	56.7	60.8	65.1
	Efficiency	84	86	87	90	92	92	93
	O.T. / Shaft	455,650	403,950	352,300	268,300	244,400	221,700	185,100
20	Me.HP	50.3	87.4	112.8	160.9	178.1	195.3	214.7
	Th.HP Std	10.8	17.6	21.7	30.4	32.2	33.8	35.4
	Th.HP Fan	16.2	26.4	32.6	45.6	48.3	50.7	53.1
	Efficiency	80	82	83	88	88	88	89
	O.T. / Shaft	443,650	395,100	344,100	269,150	240,000	217,800	183,200
25	Me.HP	40.5	70.5	91.3	129.6	144.0	158.0	173.7
	Th.HP Std	8.6	14.8	18.7	26.0	27.1	28.4	29.5
	Th.HP Fan	12.9	22.2	28.1	39.0	40.7	42.6	44.3
	Efficiency	76	80	82	86	88	88	89
	O.T. / Shaft	424,200	388,650	343,950	264,850	242,550	220,250	185,300
30	Me.HP	34.0	59.1	76.7	108.6	120.7	132.3	146.2
	Th.HP Std	9.4	12.2	15.9	21.8	23.3	24.3	25.0
	Th.HP Fan	14.1	18.3	23.9	32.7	35.0	36.5	37.5
	Efficiency	73	75	77	80	84	84	85
	O.T. / Shaft	410,500	366,550	325,600	247,750	232,900	211,250	178,750
40	Me.HP	25.6	44.5	57.7	82.2	91.4	99.9	110.0
	Th.HP Std	5.3	9.7	13.1	24.4	19.6	20.5	21.3
	Th.HP Fan	8.0	14.6	19.7	36.6	29.4	30.8	32.0
	Efficiency	66	68	72	77	80	80	81
	O.T. / Shaft	372,600	333,650	305,350	240,650	223,950	202,600	170,850
50	Me.HP	20.5	35.7	46.4	65.9	73.3	80.2	88.2
	Th.HP Std	4.2	7.7	10.7	15.2	16.1	16.9	18.2
	Th.HP Fan	6.3	11.6	16.1	22.8	24.2	25.4	27.3
	Efficiency	59	65	69	75	77	77	78
	O.T. / Shaft	333,400	319,800	294,150	234,900	216,100	195,650	164,900
60	Me.HP	17.2	29.8	38.7	55.0	61.2	66.9	73.6
	Th.HP Std	3.5	6.4	9.0	13.3	14.1	14.9	16.3
	Th.HP Fan	5.3	9.6	13.5	20.0	21.2	22.4	24.5
	Efficiency	58	64	66	71	74	74	75
	O.T. / Shaft	330,000	315,450	281,650	222,700	208,050	188,250	158,800
70	Me.HP	14.7	25.6	33.2	47.2	52.5	57.4	63.2
	Th.HP Std	3.0	5.5	7.7	11.8	13.2	13.8	15.0
	Th.HP Fan	4.5	8.3	11.6	17.7	19.8	20.7	22.5
	Efficiency	57	63	65	70	73	73	74
	O.T. / Shaft	323,350	311,200	277,600	219,850	205,400	185,850	156,950

Key: Me.HP = Mech. Input Power (HP) Th.HP Std = Ther. Input Power - No Fan
 O.T. / Shaft = Output Torque (Lb.-in) per shaft Th.HP Fan = Ther. Input Power - Fan

0107

**DuoDrive Size 20 to 240
#1 Assembly Shown**

Dimensions shown are for cast iron housing sizes D20 through D80.
Welded steel housings sizes D100 through D240.
Input and output shaft may extend on either side or may be double extended.

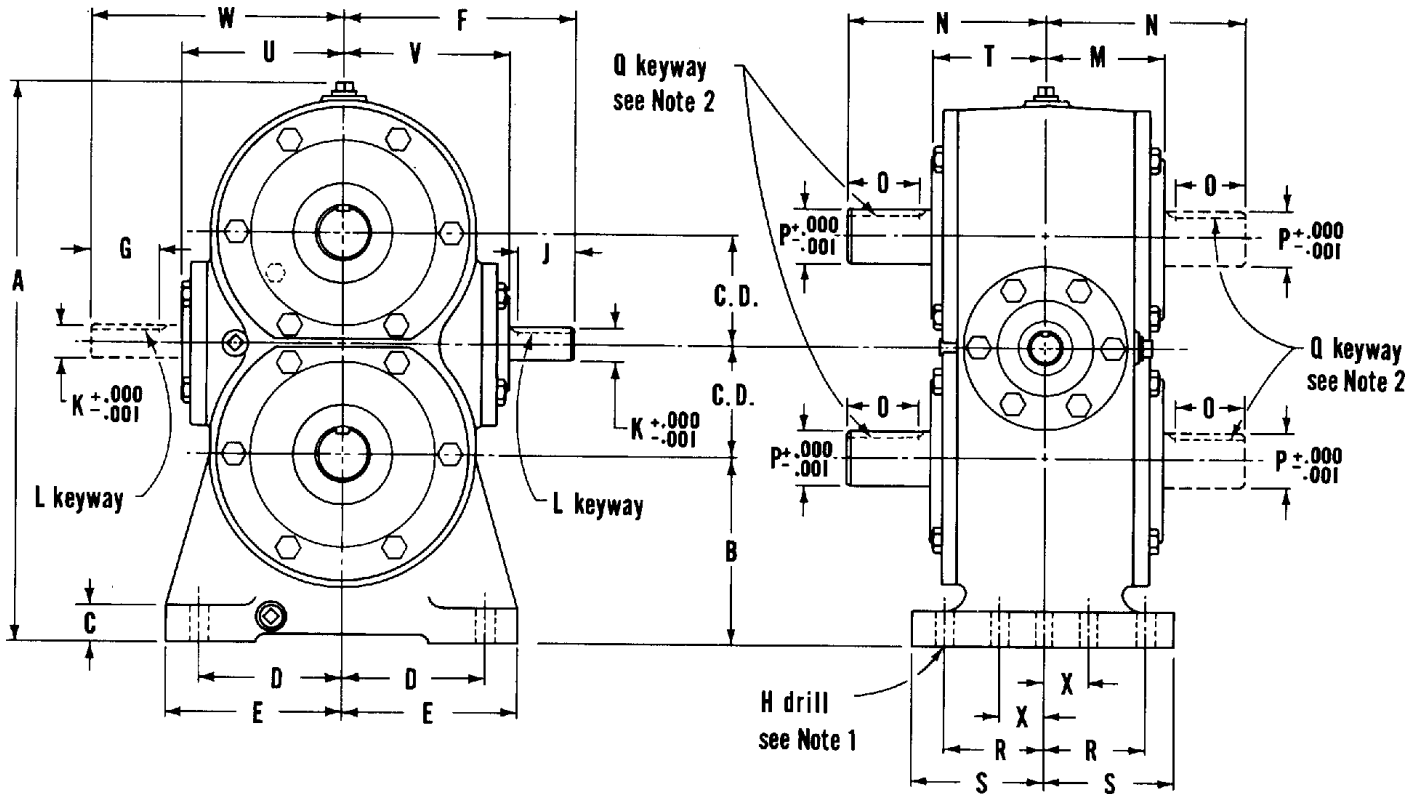

Notes:

1. Sizes D20 through D100, 4 mounting holes. Size D120, 6 mounting holes. Sizes D150 through D240, 8 mounting holes.
2. Sizes D150 through D240 have 2 keyways 180° apart, on each output shaft extension.
3. Unless otherwise specified housing will be furnished in cast iron or welded steel at our option.
4. Sizes D180 through D240 all dimensions subject to change at final design.

DuoDrive Motorizing Options

For motorizing options, please contact Textron Power Transmission.

0107

**DuoDrive Size D20 to D240
Dimensions**

Size	C.D.	A	B	C	D	E	F	G
D20	2.000	10.5	3.625	0.75	2.75	3.2	4.59	1.06
D25	2.500	12.8	4.250	0.88	3.25	3.9	5.25	1.00
D30	3.000	16.0	4.750	1.12	4.19	4.8	6.69	1.75
D35	3.500	17.5	5.375	1.25	4.88	5.7	7.75	2.63
D40	4.000	20.0	6.000	1.25	6.00	6.8	9.31	3.00
D50	5.000	23.7	6.875	1.25	7.50	8.4	10.50	3.25
D60	6.000	27.5	7.750	1.75	7.75	8.6	11.75	4.00
D70	7.000	31.3	9.000	2.12	8.50	9.5	14.50	4.50
D80	8.000	36.3	10.00	2.25	9.88	10.9	15.50	4.75
D100	10.000	44.7	12.00	1.75	12.63	13.7	19.25	4.25
D120	12.000	53.3	14.50	1.75	16.00	17.4	22.50	4.50
D150	15.000	61.8	16.00	2.25	18.25	19.8	26.25	5.50
D180	18.000	74.7	20.00	2.25	21.00	22.3	30.25	7.50
D220	21.837	90.0	23.00	2.75	25.50	27.0	34.50	9.50
D240	24.000	96.0	23.87	2.75	27.00	28.8	40.00	9.75

Size	H	J	K	L	M	N	O	P
D20	13/32	1.06	0.6875	3/16 x 3/32	2.2	4.06	1.19	1.125
D25	15/32	1.00	0.750	3/16 x 3/32	2.6	4.50	1.38	1.250
D30	9/16	1.75	1.000	1/4 x 1/8	3.4	5.94	2.00	1.500
D35	9/16	2.62	1.1875	1/4 x 1/8	4.2	7.88	2.68	1.875
D40	11/16	3.00	1.500	3/8 x 3/16	4.9	9.25	3.31	2.250
D50	13/16	3.25	1.500	3/8 x 3/16	5.7	10.31	3.62	2.750
D60	13/16	4.00	1.750	3/8 x 3/16	6.4	12.00	4.50	3.250
D70	15/16	4.50	1.875	1/2 x 1/4	7.4	13.00	4.87	3.375
D80	15/16	4.75	2.000	1/2 x 1/4	7.8	14.00	4.87	3.500
D100	1 1/16	5.00	2.375	5/8 x 5/16	9.4	15.72	5.12	4.000
D120	1 5/16	5.87	3.000	3/4 x 3/8	12.6	24.00	7.62	5.497
D150	1 5/16	8.50	3.500	7/8 x 7/16	14.7	25.00	9.50	6.500
D180	1 5/16	10.0	4.000	1 x 1/2	16.9	28.75	10.75	7.500
D220	1 9/16	10.0	4.500	1 x 1/2	21.9	36.00	12.75	9.000
D240	1 9/16	10.0	5.000	1 1/4 x 7/16	22.7	38.00	14.00	10.000

Size	Q	R	S	T	U	V	W	X
D20	1/4 x 1/8	2.19	2.7	2.4	3.0	3.0	4.59	
D25	1/4 x 1/8	2.56	3.1	2.6	3.8	3.8	5.25	
D30	3/8 x 3/16	2.81	3.5	3.4	4.7	4.7	6.69	
D35	1/2 x 1/4	3.75	4.4	4.2	5.2	5.2	7.75	
D40	1/2 x 1/4	4.25	5.0	4.9	6.0	6.0	9.31	
D50	5/8 x 5/16	4.75	5.6	5.7	7.0	7.0	10.50	
D60	3/4 x 3/8	5.63	6.5	6.4	7.7	7.7	11.75	
D70	7/8 x 7/16	6.63	7.6	7.4	9.4	9.4	14.50	
D80	7/8 x 7/16	7.38	8.4	7.8	10.8	10.8	15.50	
D100	1 x 1/2	8.38	9.5	9.4	14.5	13.4	19.25	
D120	1 1/4 x 5/8	10.88	12.3	12.6	17.2	15.7	23.25	
D150	1 1/2 x 3/4	12.25	13.8	16.1	20.2	18.3	27.88	4.12
D180	1 3/4 x 5/8	14.50	16.0	18.4	21.5	20.2	31.50	4.88
D220	2 1/2 x 7/8	18.25	19.8	22.7	24.9	23.8	37.00	6.25
D240	2 1/2 x 7/8	18.25	20.0	23.2	28.3	25.9	40.00	6.25

0107

DuoDrive Water Cooling Connection Location

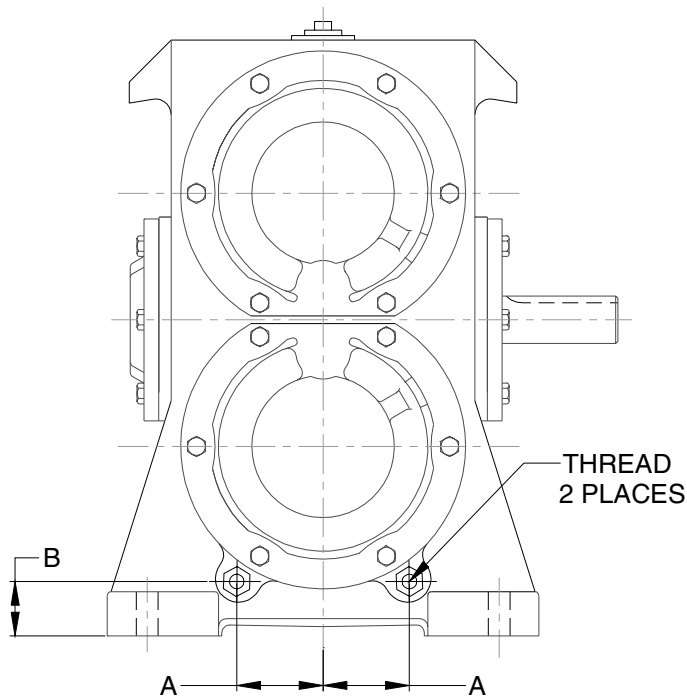

Reducer Size	A (inch)	B (inch)	Thread
D 40	3.0	1.44	3/8-NPT
D 50	3.8	1.49	3/8-NPT
D 60	4.0	1.82	3/8-NPT
D 70	4.7	1.95	3/8-NPT
D 80	5.6	2.10	3/8-NPT
D 100	7.5	2.50	3/8-NPT
D 120	6.5	3.50	1.00 - NPT
D 150	12.5	4.25	1.00 - NPT

Note: Connections for water cooling are located at the opposite side of the output shafts for single extended output reducers.

DuoDrive Water Cooling Ratings

(values shown are in horsepower)

D 40	Worm RPM								
	Ratio to 1	100	200	300	580	720	870	1150	1750
	5	6.5	11.8	16.5	23.6	24.8	28.4	29.4	30.6
	10	4.2	7.6	10.7	16.3	17.0	19.7	21.8	22.5
	15	2.9	5.3	7.5	12.5	14.3	15.8	17.1	17.6
	20	2.3	4.1	5.8	9.6	11.0	12.2	13.1	14.0
	25	1.8	3.3	4.7	7.7	8.9	9.9	11.5	12.2
	30	1.5	2.8	3.9	6.5	7.5	8.3	9.7	10.0
	40	1.2	2.1	3.0	4.9	5.6	6.3	7.3	8.3
	50	1.0	1.7	2.4	3.9	4.5	5.0	5.8	7.2
	60	0.8	1.4	2.0	3.3	3.8	4.2	4.9	6.0
	70	0.7	1.2	1.7	2.8	3.3	3.6	4.2	5.2

0107

DuoDrive Water Cooling Ratings (cont.)
(values shown are in horsepower)

D 50		Worm RPM						
Ratio to 1	100	200	300	580	720	870	1150	1750
5	12.8	23.2	32.2	37.7	39.1	45.3	46.4	47.9
10	8.2	14.9	20.8	25.1	26.0	30.6	34.2	35.0
15	5.7	10.5	14.6	20.9	22.6	24.5	26.8	27.4
20	4.4	8.0	11.2	18.0	18.6	18.9	20.1	21.5
25	3.6	6.5	9.1	14.5	16.1	17.7	18.8	19.1
30	3.0	5.4	7.6	12.2	13.7	14.4	15.0	15.2
40	2.3	4.1	5.7	9.2	10.4	11.4	12.6	12.7
50	1.8	3.3	4.6	7.4	8.3	9.2	10.7	11.2
60	1.5	2.8	3.9	6.2	7.0	7.7	8.9	10.1
70	1.3	2.4	3.3	5.3	6.0	6.6	7.7	9.4
D 60		Worm RPM						
Ratio to 1	100	200	300	580	720	870	1150	1750
5	19.5	35.1	47.9	54.8	56.8	65.9	67.5	69.7
10	12.5	22.7	30.8	36.5	37.8	44.6	49.8	50.9
15	8.8	16.0	22.1	30.3	32.9	35.7	38.9	39.8
20	6.7	12.2	16.9	25.9	27.0	27.6	29.2	31.1
25	5.4	9.9	13.7	21.0	23.4	25.8	27.3	27.6
30	4.6	8.3	11.5	17.6	19.7	21.0	21.9	22.2
40	3.4	6.2	8.6	13.3	14.8	16.5	18.3	18.5
50	2.8	5.0	6.9	10.7	11.9	13.2	15.1	16.3
60	2.3	4.2	5.8	8.9	9.9	11.0	12.6	14.6
70	2.0	3.6	5.0	7.6	8.5	9.5	10.8	13.2
D 70		Worm RPM						
Ratio to 1	100	200	300	580	720	870	1150	1750
5	30.6	54.5	72.6	105.2	109.7	128.4	130.7	133.8
10	19.7	35.6	48.7	69.2	71.0	84.9	95.5	97.1
15	13.8	25.1	34.4	51.3	57.7	63.8	73.0	75.9
20	10.6	19.2	26.4	39.4	44.4	48.8	54.7	58.7
25	8.5	15.5	21.3	31.9	35.9	39.5	45.5	52.5
30	7.2	13.0	17.9	26.8	30.1	33.1	38.1	41.6
40	5.4	9.8	13.4	20.1	22.6	24.9	28.8	34.0
50	4.3	7.9	10.8	16.2	18.2	20.0	23.1	27.3
60	3.6	6.6	9.0	13.5	15.2	16.7	19.3	22.9
70	3.1	5.7	7.7	11.6	13.0	14.3	16.5	19.6

D 80		Worm RPM						
Ratio to 1	100	200	300	580	720	870	1150	1750
5	45.3	79.8	104.5	149.3	156.5	182.2	186.7	190.1
10	29.3	52.9	71.6	97.6	99.6	120.2	135.7	137.5
15	20.6	37.3	50.8	74.8	84.2	93.0	105.9	107.3
20	15.8	28.6	39.0	57.6	64.7	71.6	76.8	82.4
25	12.7	23.0	31.5	46.7	52.5	57.7	66.2	74.3
30	10.7	19.3	26.4	39.1	44.1	48.6	55.7	58.4
40	8.0	14.6	19.9	29.5	33.2	36.6	41.9	48.1
50	6.5	11.7	16.0	23.7	26.6	29.4	33.6	39.3
60	5.4	9.8	13.3	19.8	22.2	24.5	28.1	32.8
70	4.6	8.4	11.4	17.0	19.1	21.0	24.1	28.2
D 100		Worm RPM						
Ratio to 1	100	200	300	580	720	870	1150	1750
5	84.7	143.9	183.2	254.0	286.8	311.0	337.9	345.2
10	55.1	97.3	116.8	137.4	176.9	179.3	211.3	214.1
15	38.7	68.7	83.5	110.2	133.5	135.4	152.8	154.9
20	29.6	52.7	65.7	92.8	94.1	95.3	102.9	112.0
25	23.9	42.5	56.6	79.5	90.5	91.4	98.6	99.4
30	20.0	35.7	47.4	58.3	69.9	70.7	74.7	75.3
40	15.1	26.8	35.7	51.4	56.7	57.4	60.1	60.7
50	12.1	21.6	28.7	41.5	46.3	49.2	51.8	52.7
60	10.1	18.0	24.0	34.6	38.6	42.3	45.8	46.5
70	8.7	15.5	20.6	29.7	33.2	36.3	41.4	43.8
D 120		Worm RPM						
Ratio to 1	100	200	300	580	720	870	1150	
5	132.9	166.3	210.2	227.4	290.8	298.5	304.3	
10	72.9	91.7	106.5	127.9	161.9	165.2	193.0	
15	56.0	68.7	77.4	102.7	122.6	125.3	140.3	
20	44.7	55.3	61.6	86.9	88.7	90.3	97.1	
25	36.9	48.7	56.4	74.5	83.6	84.9	91.2	
30	34.0	39.3	45.4	55.7	65.7	66.7	70.2	
40	25.3	30.9	37.3	53.9	53.5	54.4	57.0	
50	20.5	27.1	32.6	42.3	45.6	46.4	49.0	
60	17.2	25.2	29.0	36.7	40.2	41.0	43.4	
70	14.7	23.8	27.1	34.4	38.3	38.9	41.1	

Contact Textron Power Transmission for ratings above Size D120.

Standard Hollow Gearshaft Bores

0107

DuoDrive Standard Hollow Gearshaft Bores, Sizes D20 through D120

Size	Bore Inches	Gearshaft Numbers	Keyway Size	Bore Tolerance
20	1.375 *	20-S60-106	1/4 x 1/8	+.002, -.000
	1.250 *	20-S60-104	1/4 x 1/8	+.002, -.000
	1.1875 *	20-S60-103	1/4 x 1/8	+.002, -.000
	1.125 *	20-S60-102	1/4 x 1/8	+.002, -.000
	1.000 *	20-S60-100	1/4 x 1/8	+.002, -.000
25	2.000 *	25-S60-200	1/4 x 1/8	+.002, -.000
	1.9375 *	25-S60-115	1/4 x 1/8	+.002, -.000
	1.6875 *	25-S60-111	3/8 x 3/16	+.002, -.000
	1.4375 *	25-S60-107	3/8 x 3/16	+.002, -.000
	1.250 *	25-S60-104	1/4 x 1/8	+.002, -.000
	1.1875 *	25-S60-103	1/4 x 1/8	+.002, -.000
30	2.500	30-S60-208	3/8 x 3/16	+.002, -.000
	2.4375 *	30-S60-207	3/8 x 3/16	+.002, -.000
	2.1875 *	30-S60-203	1/2 x 1/4	+.002, -.000
	1.9375 *	30-S60-115	1/2 x 1/4	+.002, -.000
	1.6875 *	30-S60-111	3/8 x 3/16	+.002, -.000
	1.500 *	30-S60-108	3/8 x 3/16	+.002, -.000
35	2.750	35-S60-212	3/8 x 3/16	+.002, -.000
	2.6875 *	35-S60-211	3/8 x 3/16	+.002, -.000
	2.500	35-S60-208	3/8 x 3/16	+.002, -.000
	2.4375 *	35-S60-207	5/8 x 3/16	+.002, -.000
	2.1875 *	35-S60-203	1/2 x 1/4	+.002, -.000
	1.9375 *	35-S60-115	1/2 x 1/4	+.002, -.000
	1.6875 *	35-S60-111	3/8 x 3/16	+.002, -.000
40	2.9375 *	40-S60-215	5/8 x 3/16	+.003, -.000
	2.6875 *	40-S60-211	5/8 x 3/16	+.003, -.000
	2.4375 *	40-S60-207	5/8 x 3/16	+.003, -.000
	2.1875	40-S60-203	5/8 x 3/16	+.003, -.000
50	3.4375 *	50-S60-307	5/8 x 3/16	+.003, -.000
	3.1875 *	50-S60-303	5/8 x 3/16	+.003, -.000
	2.750	50-S60-212	5/8 x 3/16	+.003, -.000
60	3.9375 *	60-S60-315	3/4 x 3/8	+.003, -.000
	3.4375 *	60-S60-307	3/4 x 3/8	+.003, -.000
	2.9375 *	60-S60-215	3/4 x 3/8	+.003, -.000
70	4.4375 *	80-S60-407	1 x 1/2	+.003, -.000
	3.9375 *	80-S60-315	1 x 1/2	+.003, -.000
80	4.4375 *	80-S60-407	1 x 1/2	+.003, -.000
	3.9375 *	80-S60-315	1 x 1/2	+.003, -.000
100	5.9375	100-S61-515	1 1/4 x 7/16	+.004, -.000
120	7.9375	120-S61-715	1 1/2 x 1/2	+.004, -.000

Notes:

Special hollow gearshaft bore sizes are available at additional cost.

All sizes have 2 set screws at long end of shaft.

* Bore inches AGMA Standard.

Assembly & Mounting Positions

0107

DuoDrive Assembly & Mounting Position Numbers

Top View, Floor Mounted

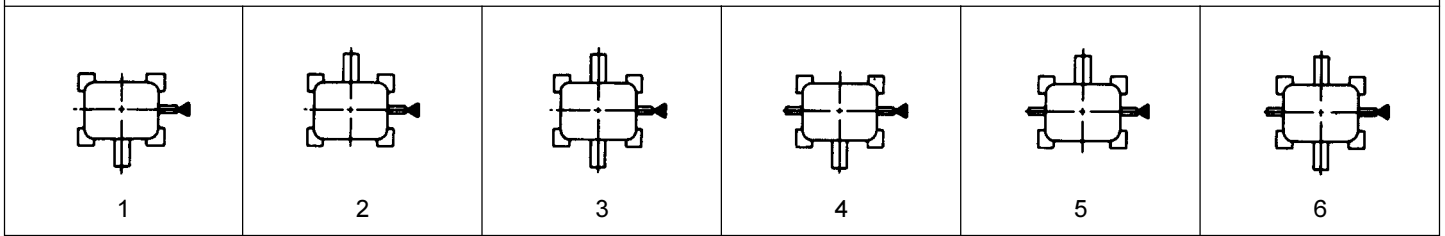

Ceiling Mounted

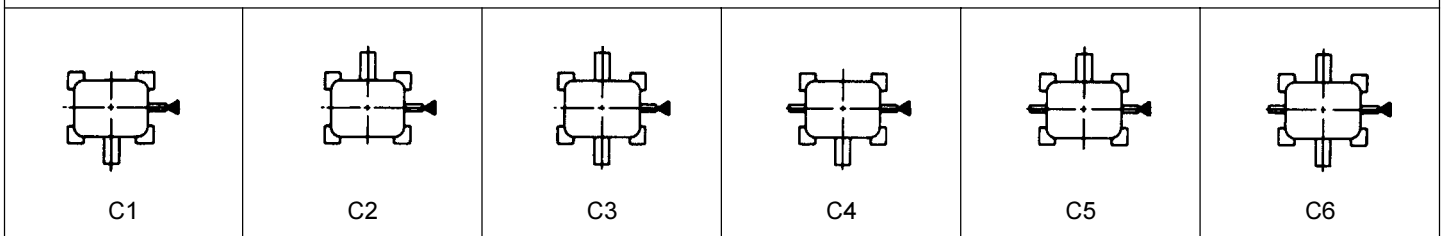

Wall Mounted, Worm Vertical Up

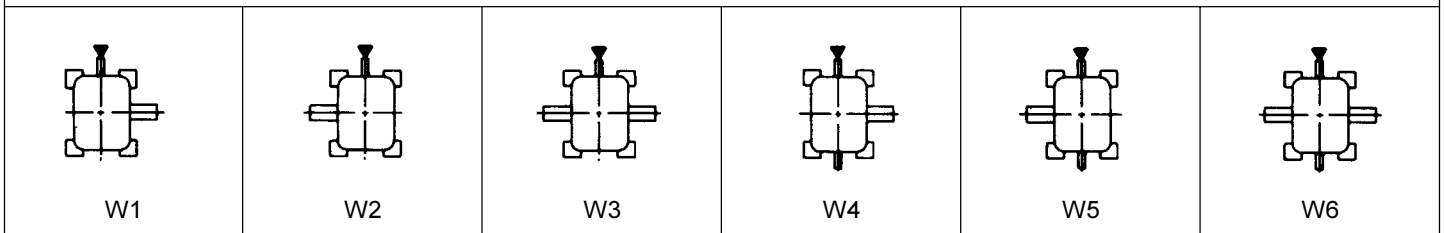

Wall Mounted, Worm Vertical Down

Size 100 and larger - contact Textron Power Transmission regarding lubrication of upper worm bearing.

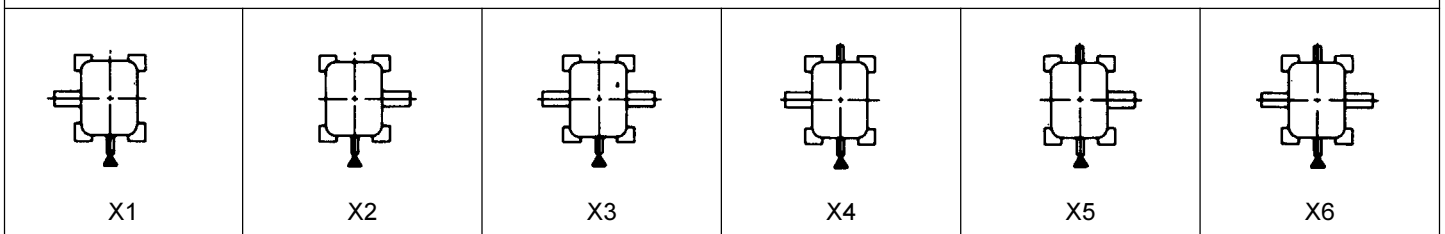

Wall Mounted, Worm Horizontal to the Left

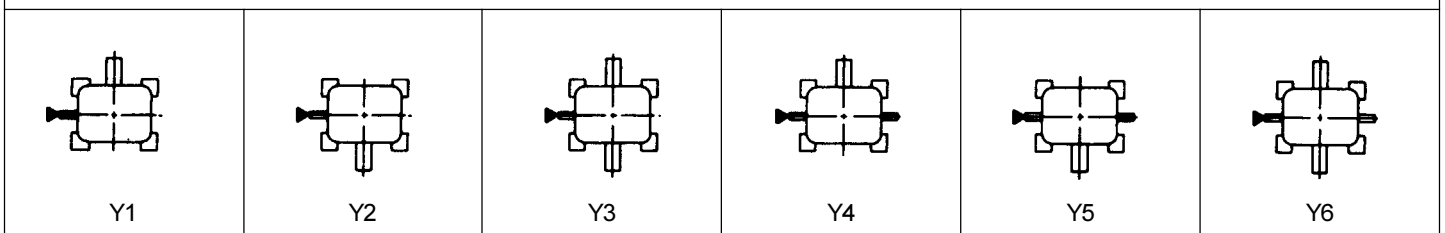

Wall Mounted, Worm Horizontal to the Right

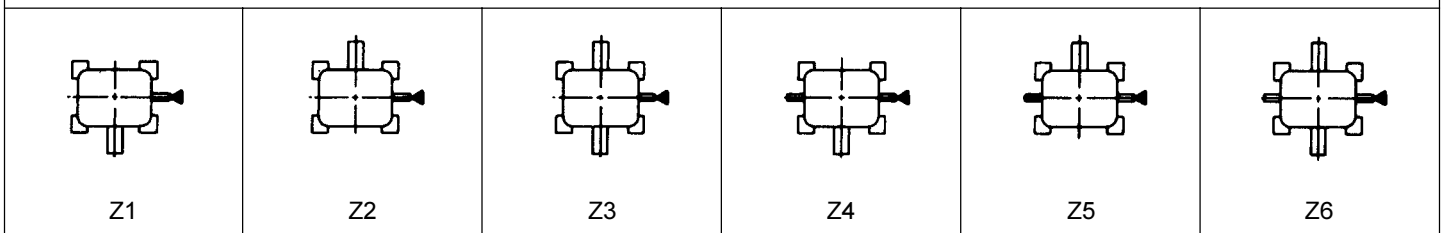

0107

0107

IMPORTANT

General - The following information is important in ensuring safety. It **must** be brought to the attention of personnel involved in the selection of Textron Power Transmission equipment, those responsible for the design of the machinery in which it is to be incorporated and those involved in its installation, use and maintenance.

Textron Power Transmission equipment will operate safely provided it is selected, installed, used and maintained properly. As with any power transmission equipment **proper precautions must** be taken as indicated in the following paragraphs, to ensure safety.

Potential Hazards - these are **not** necessarily listed in any order of severity as the degree of danger varies in individual circumstances. It is important therefore that the list is studied in its entirety:

- 1) Fire/Explosion
 - (a) Oil mists and vapor are generated within gear units. It is therefore dangerous to use naked lights in the proximity of gearbox openings, due to the risk of fire or explosion.
 - (b) In the event of fire or serious overheating (over 570 °F (300°C)), certain materials (rubber, plastics, etc.) may decompose and produce fumes. Care should be taken to avoid exposure to the fumes, and the remains of burned or overheated plastic/rubber materials should be handled with rubber gloves.
 - 2) Guards - Rotating shafts and couplings must be guarded to eliminate the possibility of physical contact or entanglement of clothing. It should be of rigid construction and firmly secured.
 - 3) Noise - High speed gearboxes and gearbox driven machinery may produce noise levels which are damaging to the hearing with prolonged exposure. Ear plugs should be provided for personnel in these circumstances. Reference should be made to state and federal regulations for reducing exposure of employed persons to noise.
 - 4) Lifting - Where provided (on larger units) only the lifting points or eyebolts must be used for lifting operations (see maintenance manual or general arrangement drawing for lifting point positions). Failure to use the lifting points provided may result in personal injury and/or damage to the product or surrounding equipment. Keep clear of raised equipment.
 - 5) Lubricants and Lubrication
 - (a) Prolonged contact with lubricants can be detrimental to the skin. The manufacturer's instruction must be followed when handling lubricants.
 - (b) The lubrication status of the equipment must be checked before commissioning. Read and carry out all instructions on the lubricant plate and in the installation and maintenance literature. Heed all warning tags. Failure to do so could result in mechanical damage and in extreme cases risk of injury to personnel.
 - 6) Electrical Equipment - Observe hazard warnings on electrical equipment and isolate power before working on the gearbox or associated equipment, in order to prevent the machinery being started.
 - 7) Installation, Maintenance and Storage
 - (a) In the event that equipment is to be held in storage, for a period exceeding 6 months, prior to installation or commissioning, Textron must be consulted regarding special preservation requirements. Unless otherwise agreed, equipment must be stored in a building protected from extremes of temperature and humidity to prevent deterioration.
- The rotating components (gears and shafts) must be turned a few revolutions once a month (to prevent bearings brinelling).
- (b) External gearbox components may be supplied with preservative materials applied, in the form of a "waxed" tape overwrap or wax film preservative. Gloves should be worn when removing these materials. The former can be removed manually, the latter using white spirit as a solvent.
- Preservatives applied to the internal parts of the gear units do not require removal prior to operation.
- (c) Installation must be performed in accordance with the manufacturer's instructions and be undertaken by suitably qualified personnel.
 - (d) Before working on a gearbox or associated equipment, ensure that the load has been removed from the system to eliminate the possibility of any movement of the machinery and isolate power supply. Where necessary, provide mechanical means to ensure the machinery cannot move or rotate. Ensure removal of such devices after work is complete.
 - (e) Ensure the proper maintenance of gearboxes in operation. Use only the correct tools and Textron approved spare parts for repair and maintenance. Consult the Maintenance Manual before dismantling or performing maintenance work.
- 8) Hot Surfaces and Lubricants
 - (a) During operation, gear units may become sufficiently hot to cause skin burns. Care must be taken to avoid accidental contact.
 - (b) After extended running the lubricant in gear units and lubrication systems may reach temperatures sufficient to cause burns. Allow equipment to cool before servicing or performing adjustments.
 - 9) Selection and Design
 - (a) Where gear units provide a backstop facility, ensure that back-up systems are provided if failure of the backstop device would endanger personnel or result in damage.
 - (b) The driving and driven equipment must be correctly selected to ensure that the complete machinery installation will perform satisfactorily, avoiding system critical speeds, system torsional vibration, etc.
 - (c) The equipment must not be operated in an environment or at speeds, powers, torques or with external loads beyond those for which it was designed.
 - (d) As improvements in design are being made continually the contents of this catalog are not to be regarded as binding in detail, and drawings and capacities are subject to alterations without notice.
- The above guidance is based on the current state of knowledge and our best assessment of the potential hazards in the operation of the gear units.

Contact Textron Power Transmission

0107

AUSTRALIA

David Brown Gear Industries Ltd
13-19 Franklin Avenue
Bulli, NSW 2516
Australia
Tel: +61 2 4283 0300
Fax: +61 2 4283 0333

AUSTRIA

Benzler Antriebstechnik GmbH
Urnenhainweg 7
AT-4050 Traun
Austria
Tel: +43 7 229 618 91
Fax: +43 7 229 618 84

BELGIUM

Benzlers Belgium
Contact the Northern European Service Centre (Netherlands)
Tel: +32 25 82 59 22
Fax: +32 25 82 68 47

CANADA

David Brown Radicon Inc
975 Dillingham Road
Pickering, Ontario
L1W 3B2
Canada
Tel: +01 905 420 4141
Fax: +01 905 420 9513

DENMARK

Benzler Transmission A/S
Hammerholmen 39
DK-2650 Hvidovre
Denmark
Tel: +45 36 34 03 00
Fax: +45 36 77 02 42

FINLAND

Oy Benzler AB
PB 3
FI02211 Espoo
Finland
Tel: +358 9 8870 630
Fax: +358 9 8870 631

FRANCE

Benzler France
Contact the Northern European Service Centre (Netherlands)
Tel: +33 130 32 79 00
Fax: +33 130 32 80 40

David Brown Transmissions France SA

42 Avenue du Progrès, BP 149
69686 Chassieu Cedex
France
Tel: +33 4 72 47 61 50
Fax: +33 4 72 47 61 69

DSN

9 rue de la Verrerie, BP 135
ZI Le Fontanil Cedex
38521 El Fontanil
France
Tel: +33 4 76 75 66 83
Fax: +33 4 76 75 57 99

WECO

33 Rue Henri-Lebert, BP 48
68801 Thann Cedex
France
Tel: +33 3 89 37 01 13
Fax: +33 3 89 37 39 36

GERMANY

Benzler Germany
Contact the Northern European Service Centre (Netherlands)
Tel: 0800 350 40 00
Fax: 0800 350 40 01

HUNGARY

Benzler Antriebstechnik GmbH
Urnenhainweg 7
AT-4050 Traun
Austria
Tel: +43 7 229 618 91
Fax: +43 7 229 618 84

ITALY

Benzler Ferri SpA
Via F.lli Rosselli 16
IT 42019 Scandiano (RE)
Italy
Tel: +39 05 22 763314
Fax: +39 05 22 981758

MALAYSIA

Benzler (M) Sdn Bhd
No 24 Jalan TPJ 3
Taman Perindustrian
Jaya Subang
MY 47200 Selangor
Malaysia
Tel: +60 3 745 0668
Fax: +60 3 746 1436

NETHERLANDS

Northern European Service Centre & HQ Benzlers Netherland
Postbox 3303
NL 5902 Venlo RH
Netherlands
Tel: +31 773 245 900
Fax: +31 773 245 901

NORWAY

Textron Power Transmission (Norvege)
Incorporating Benzler A/S & David Brown Hydraulics Norway A/S
PO Box 73 Leirdal
Stromsveien 372
NO- 1008 Oslo
Norway
Tel: +47 22 90 94 30
Fax: +47 22 90 94 11

PHILIPPINES

David Brown John Welsh Custom Build (Pty) Ltd
Unit 1207 One Magnificent Mile
San Miguel Ave, Ortigas Centre
Pasig City, Philippines
Tel: +63 6 32 910 0316
Fax: +63 6 32 910 0317

SINGAPORE

Benzler (FE) Pte Ltd
1 Clementi Loop
#03-08
Singapore 129808
Tel: +65 469 0777
Fax: +65 469 2083

SOUTH AFRICA

David Brown Gear Industries Ltd
PO Box 540, Benoni 1500
South Africa
Tel: +27 11 748 0000
Fax: +27 11 421 2963

David Brown Gear Industries Ltd
PO Box 36882
Chempet 7442
Cape Town
South Africa
Tel: +27 21 551 2163
Fax: +27 21 551 2164

David Brown Gear Industries Ltd
Natal Sales Office
39 Richmond Road
Pinetown 3600
Natal, South Africa
Tel: +27 31 700 3302
Fax: +27 31 700 1872

SWEDEN

AB Benzlers
PO Box 922
SE-251 09 Helsingborg
Sweden
Tel: +46 42 18 6800
Fax: +46 42 21 8803

THAILAND

David Brown Powauto (Thailand) Ltd
Level 5 Sermrap Building
169/98 Ratchadapisek Road
Din Daeng, Bangkok 10320
Thailand
Tel: +66 2 276 9504/5/6
Fax: +66 2 276 9503

UNITED KINGDOM

Textron Power Transmission Corporate HQ
Park Road
Lockwood, Huddersfield
West Yorkshire. HD4 5DD
Tel: +44 (0) 1484 465500
Fax: +44 (0) 1484 465501

David Brown Engineering Ltd
Park Road
Lockwood, Huddersfield
West Yorkshire. HD4 5DD
Sales
Tel: 0800 970 4001
Fax: 0800 970 4002
Service & Spare Parts
Tel: 0800 970 4003
Fax: 0800 970 4004

USA

Cone Drive Textron
240 East 12th Street
Traverse City
MI 49684
USA
Tel: +01 231 946 8410
Fax: +01 231 933 8600

AGRICULTURE

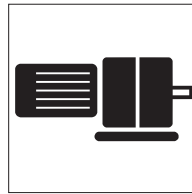

Geared motors

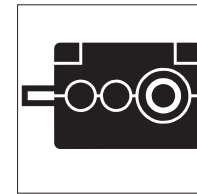

Industrial reducers

AUTOMOTIVE

CEMENT



Worm

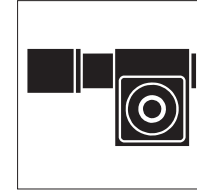

Precision products

CHEMICAL

CONSTRUCTION

DEFENCE

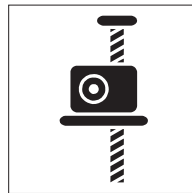

Screwjacks

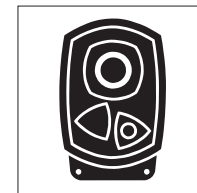

Shaftmount

ENERGY

FOOD & BEVERAGE

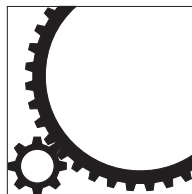

Horizontal mill drives

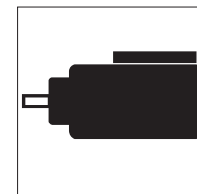

Vertical mill drives

FORESTRY

MARINE

METALS

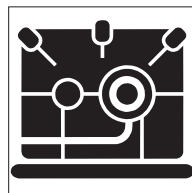

High speed

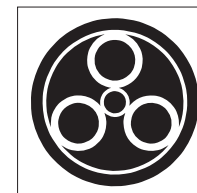

Planetary units

MINING

PULP & PAPER

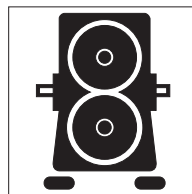

Specialist drives

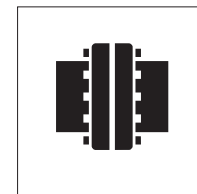

Couplings

QUARRYING

RUBBER & PLASTICS

TEXTILES



Defence Systems

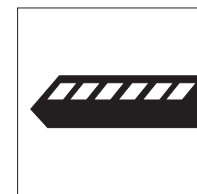

Rail

TRANSPORTATION

WATER

TEXTRON POWER TRANSMISSION

www.TextronPT.com